

# SERVICE MANUAL

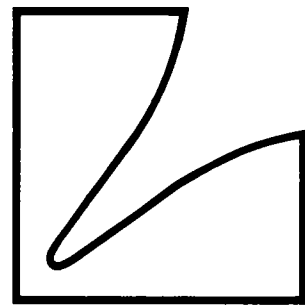

Stereo Integrated Amplifier

# LV-105

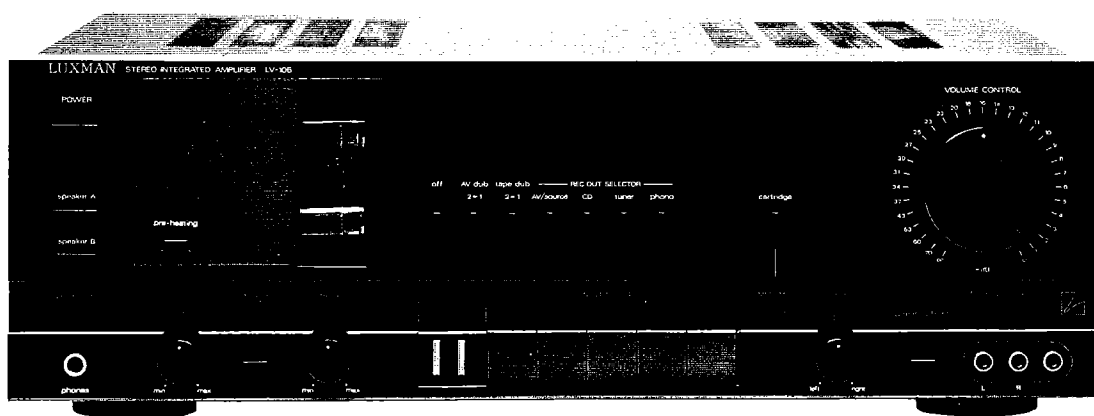

---

## Contents

---

Specifications . . . . .	3
Parts Locations and Disassembly Instructions . . . . .	4 to 8
Adjustment Procedures . . . . .	9
Adjustment Locations . . . . .	9
Block Diagram . . . . .	10
Parts Layout on P.C. Boards and Wiring Diagram . . . . .	11 to 16
Schematic Diagram . . . . .	17 to 18
Electrical Parts List . . . . .	19 to 24
Exploded View (Cabinet) . . . . .	25 to 26
Cabinet Assembly Parts List . . . . .	27
Packing Method View . . . . .	28
Packing Assembly Parts List . . . . .	28
Semi-conductor Lead Identifications . . . . .	29 to 30

---

# Specifications

Power-Output	70W (0.25% THD at 20 ~ 20 kHz)
Head-phones Output	(80W/8 ohm - 1 kHz) 425mV ±10%
Input Sensitivity (1 kHz)	TUNER: 150mV ±10%, CD: 150mV ±10%, TAPE-1, -2: 150mV ±10%, AV-1, -2: 150mV ±10%, PHONO (MM): 2.3mV ±10%, PHONO (MC): 53.5 dBf ±10%
Input Impedance (1 kHz)	TUNER: 45K ohm ±10%, CD: 45K ohm ±10%, TAPE-1, -2: 45K ohm ±10%, AV-1, -2: 45K ohm ±10%, PHONO (MM): 47K ohm ±10%, PHONO (MC): 100 ohm ±10%
Frequency Response	TUNER: 10 - 100 kHz +0.6 -2 dB, CD: 10 - 100 kHz +0.6 -2 dB, TAPE-1, -2: 10 - 100 kHz +0.6 -2 dB, PHONO (MM): 100 Hz ±0.5 dB, PHONO (MC): 10 kHz ±0.5 dB
Signal to Noise Ratio (Input Terminal Shorted)	TUNER: 86 dB, CD: 86 dB, TAPE-1, -2: 86 dB, AV-1, -2: 86 dB, PHONO (MM): 70 dB, PHONO (MC): 46 dB
Power Supply	120V, 60 Hz
Power Consumption	250W
Semiconductors	3 ICs, 39 Transistors, 10 FETs, 10 Zener Diodes, 32 Diodes, 2 Vacuum Tubes
Dimension	438(W) x 148(H) x 353(D) mm
Weight	10.2 kg

**NOTE:** Due to continuing product improvement, specifications and design are subject to change without notice.

# Parts Locations and Disassembly Instructions

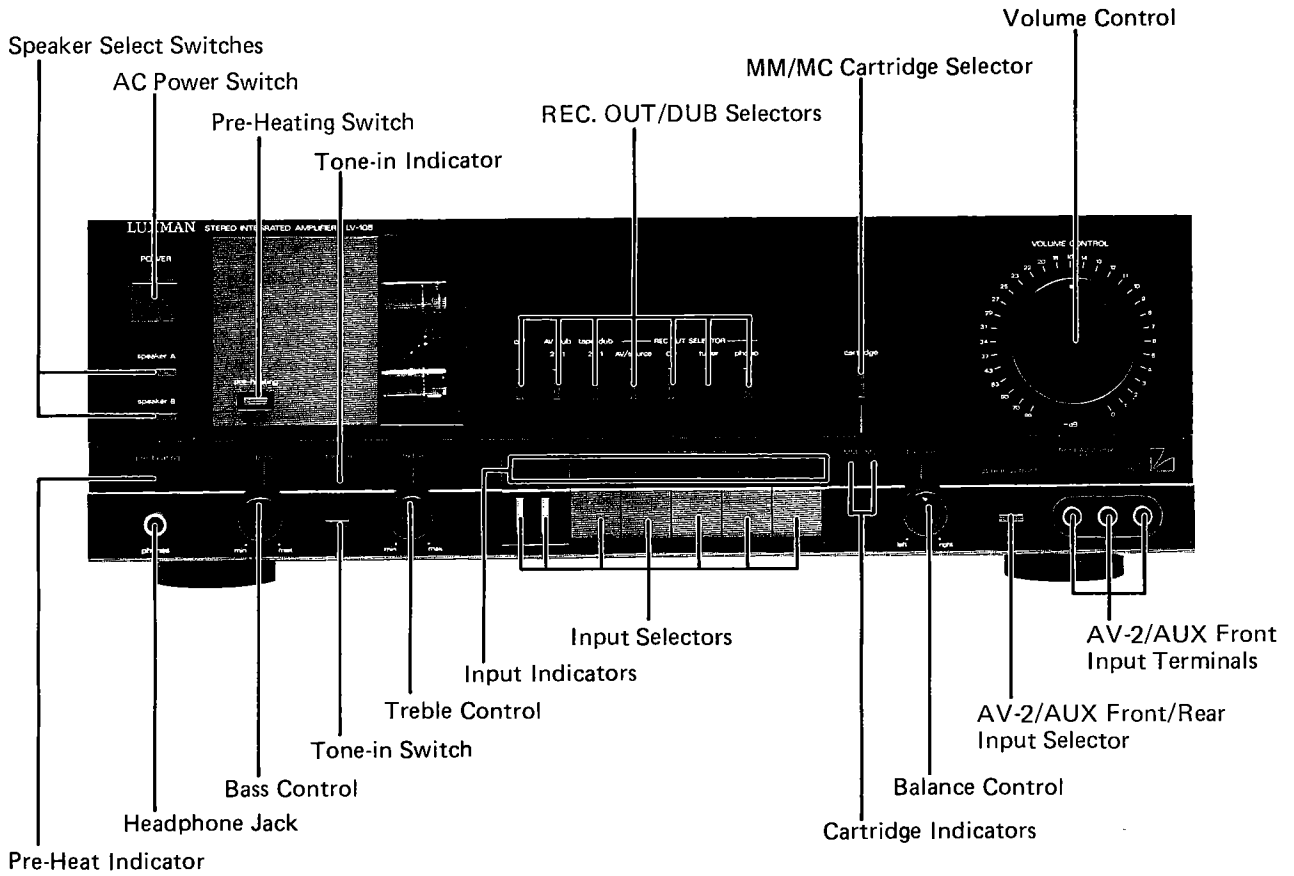

Figure 1

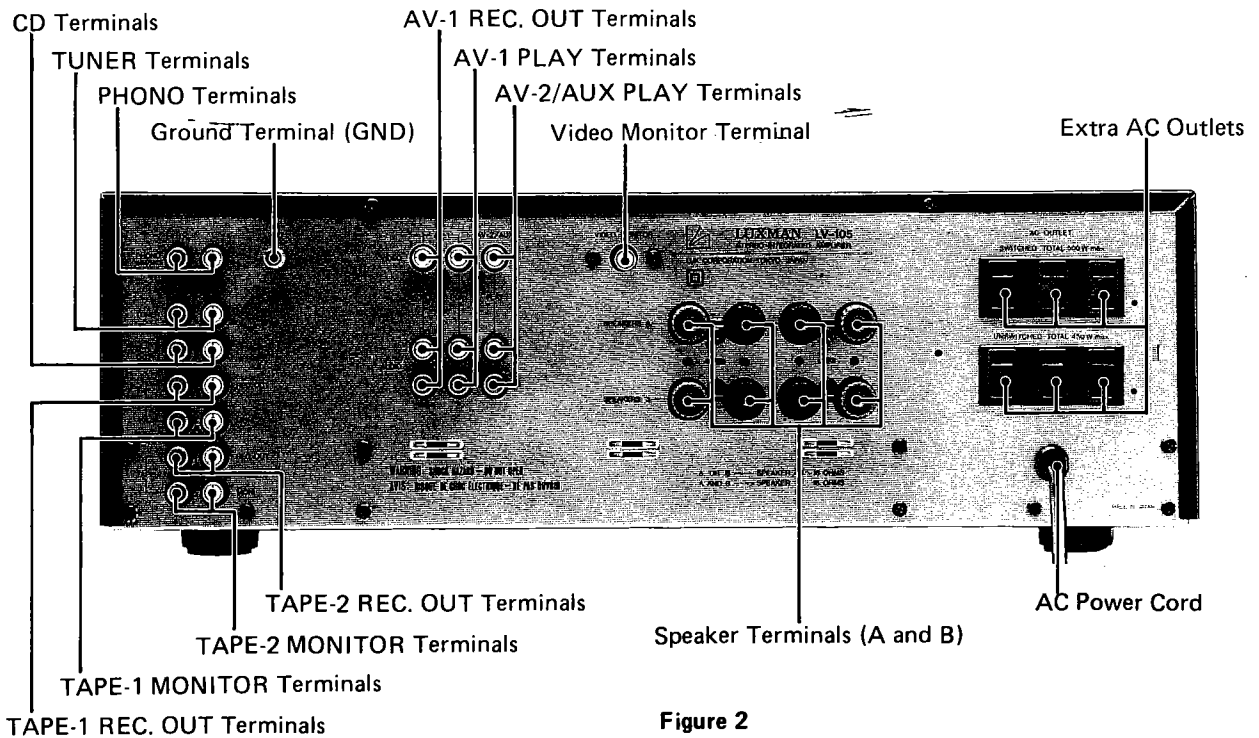

Figure 2

**1. Removal of Top Cover**

- (1) Remove six screws marked "○" as shown in Figure 3 and 4.
- (2) Pull out the Top cover in the direction of the arrow as shown in Figure 3.

**2. Removal of Front Panel**

- (1) Remove the volume control knob as shown in Figure 3.
- (2) Remove three screws marked "△" as shown in Figure 5.
- (3) Front panel can be removed by pulling it forward. But when the panel is engaged tightly, pull the panel end little by little, and the panel will be removed easily.

**3. Removal of Front Escutcheon**

- (1) After removal of Front Panel, remove three control knobs (bass, treble, balance), remove two hooks (a), and remove six screws marked "※" as shown in Figure 3, 4 and 6.
- (2) Disconnect all wires from the Front Escutcheon.
- (3) The Front Escutcheon with Function, Tone and Headphone P.C. Boards can be removed completely.

**4. Removal of Function/LED P.C. Board**

- (1) After removal of Front Escutcheon, remove four hooks (b) as shown in Figure 7.

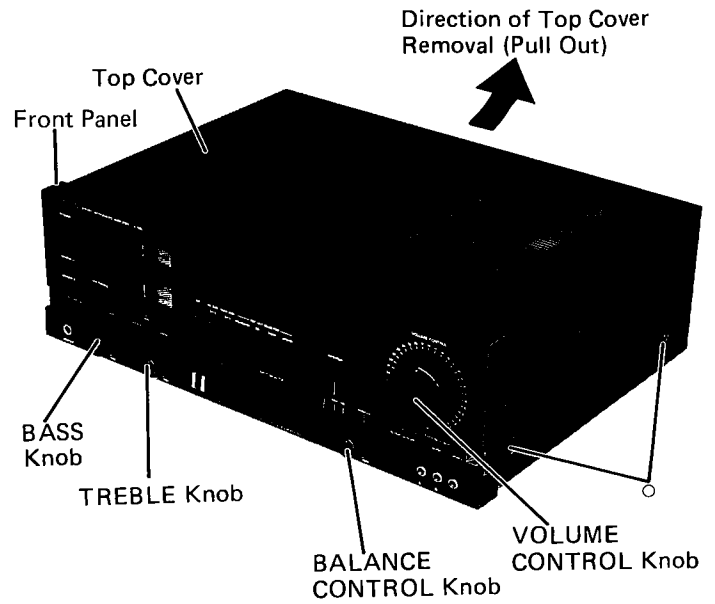

Figure 3

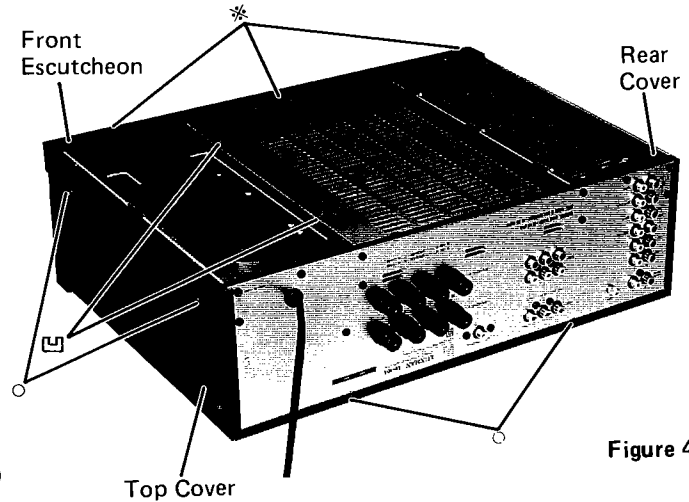

Figure 4

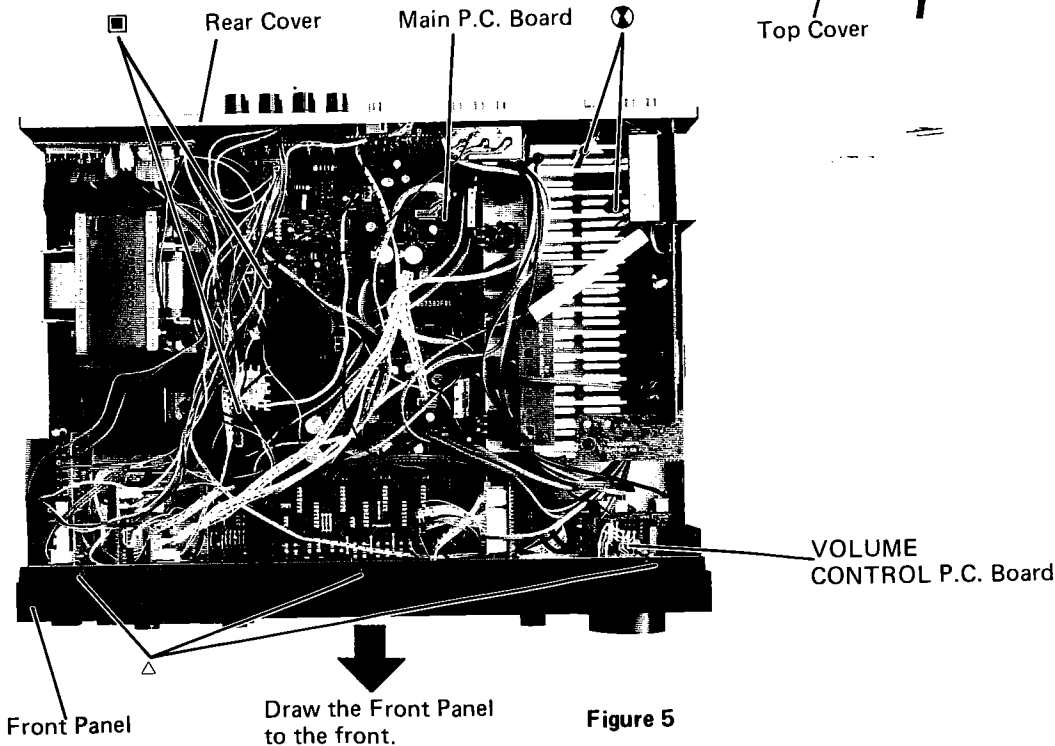

Figure 5

### 5. Removal of Tone P.C. Board

- (1) After removal of Front Escutcheon, remove two hooks (c) as shown in Figure 7.

### 6. Removal of Headphone P.C. Board

- (1) After removal of Front Escutcheon, remove two screws marked "◎" as shown in Figure 7.

### 7. Removal of Front Chassis

- (1) After removal of Front Escutcheon, remove seven screws marked "☆" as shown in Figure 8.
- (2) Remove Front Chassis upward and then proceed to items 7-1 ~ 7-9.

#### 7-1. Removal of Speaker Switch P.C. Board

- (1) Remove three knobs (A) and remove four screws marked "▲" as shown in Figure 6.
- (2) Disconnect all wires from the Speaker Switch P.C. Board.

#### 7-2. Removal of Heat-UP Switch P.C. Board

- (1) Remove one knob (B) and remove two screws marked "▽" as shown in Figure 6.
- (2) Disconnect all wires from the Heat up Switch P.C. Board.

#### 7-3. Removal of Tube P.C. Board

- (1) Remove two screws marked "■" as shown in Figure 9.
- (2) Remove one hook (d) as shown in Figure 6.
- (3) Disconnect all wires from the Tube P.C. Board.

#### 7-4. Removal of Rec Selector P.C. Board

- (1) Remove two screws marked "■" and remove seven knobs (c) as shown in Figure 6.
- (2) Disconnect all wires from the Rec Selector P.C. Board.

#### 7-5. Removal of MM/MC P.C. Board

- (1) Remove one knob (D) and remove two screws marked "□" as shown in Figure 6.
- (2) Disconnect all wires from the MM/MC P.C. Board.

#### 7-6. Removal of Volume Control P.C. Board

- (1) Remove one nut (A) and one washer (A) as shown in Figure 8.
- (2) Disconnect all wires from the Volume Control P.C. Board.

#### 7-7. Removal of Tone Control P.C. Board

- (1) Remove one knob (E) and six screws marked "●" as shown in Figure 8.
- (2) Remove two nuts (B) as shown in Figure 8.
- (3) Disconnect all wires from the Tone Control P.C. Board.

#### 7-8. Removal of Function P.C. Board

- (1) Remove seven knobs (F) and remove four screws marked "●" as shown in Figure 8.
- (2) Remove one nut (c) as shown in Figure 8.
- (3) Disconnect all wires from the Function P.C. Board.

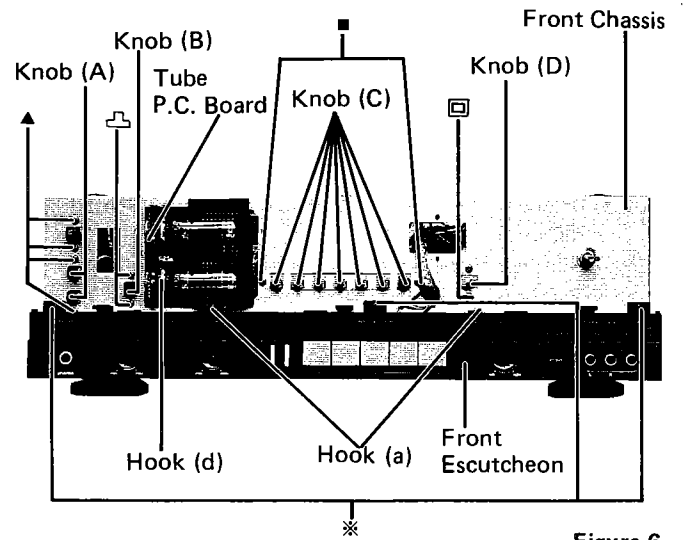

Figure 6

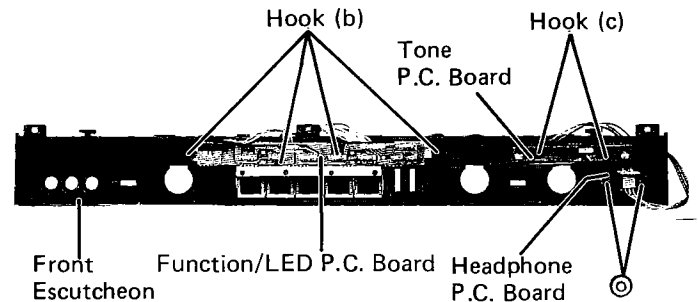

Figure 7

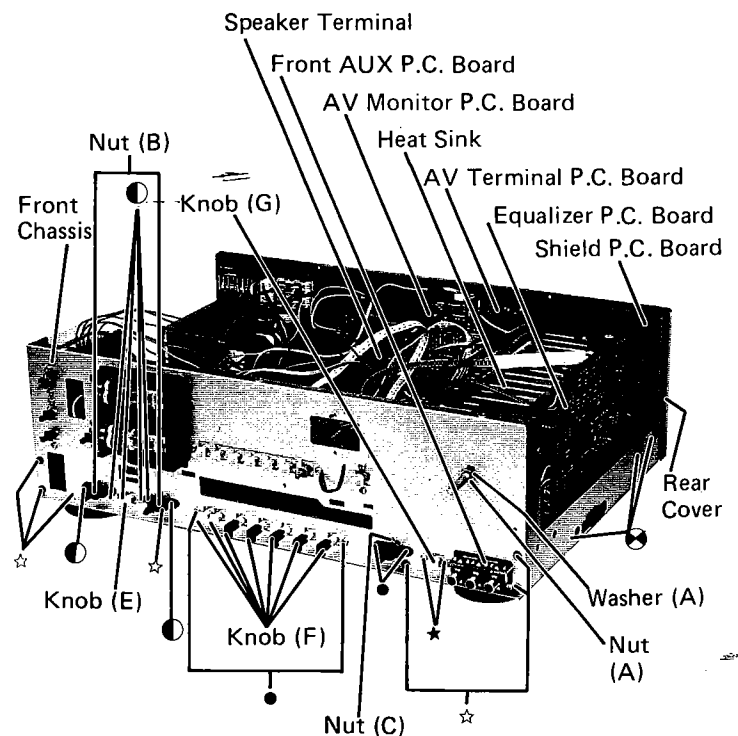

Figure 8

**7-9. Removal of Front AUX P.C. Board**

- (1) Remove one knob (G) and remove two screws marked "★" as shown in Figure 8.
- (2) Disconnect all wires from the Front AUX P.C. Board.

**8. Removal of AV Terminal P.C. Board and AV Monitor P.C. Board**

- (1) Remove six screws marked "▽" as shown in Figure 10.
- (2) Disconnect all wires from there P.C. Board.

**9. Removal of Equalizer P.C. Board**

- (1) Remove ten screws marked "⊗" as shown in Figure 5, 8 and 10.
- (2) Disconnect all wires from the Equalizer P.C. Board.

**10. Removal of Speaker Terminal P.C. Board**

- (1) Remove four screws marked "⊗" as shown in Figure 10.
- (2) Disconnect all wires from the Speaker Terminal P.C. Board.

**11. Removal of Rear Cover**

- (1) After removal of Equalizer P.C. Board remove ten screws marked "△" as shown in Figure 10.
- (2) Remove two screws marked "☐" as shown in Figure 4.
- (3) Disconnect all wires from the AC outlet.

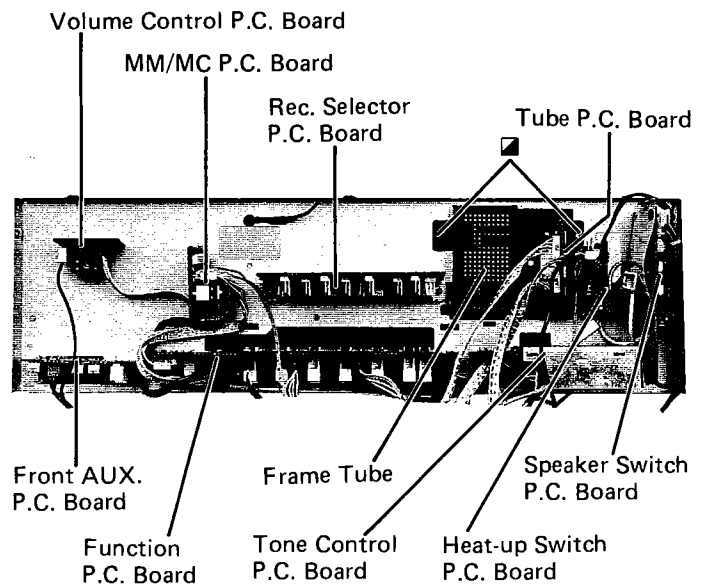

Figure 9

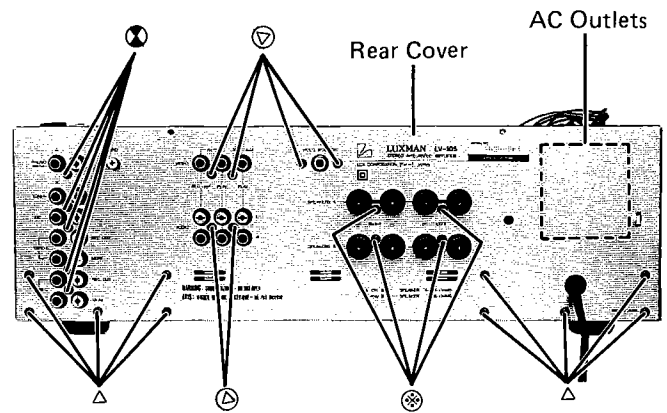

Figure 10

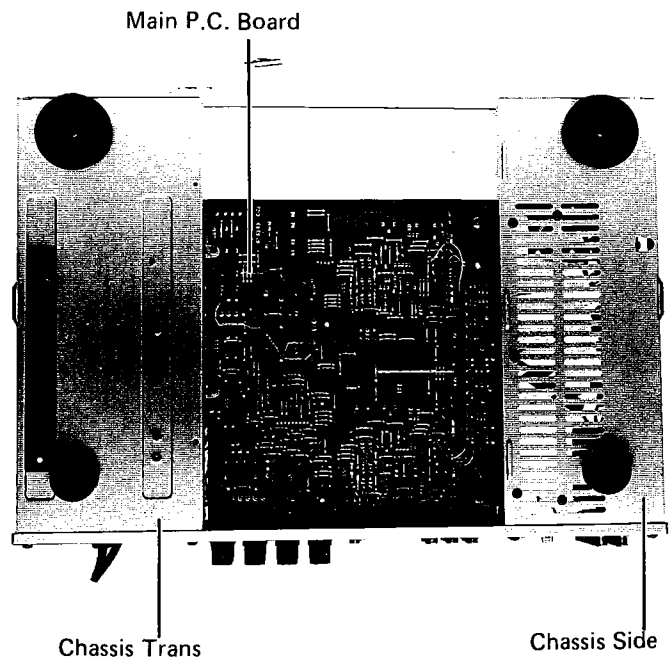

Figure 11

## 12. Removal of Main P.C. Board

- (1) After removal of Equalizer P.C. Board and Rear Cover, remove four screws marked "■" as shown in Figure 5 and 13.
- (2) Disconnect all wires from the Main P.C. Board.

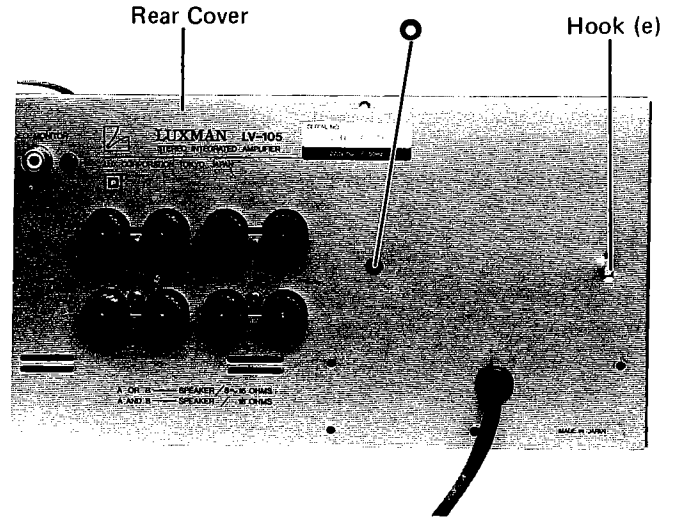

Figure 12

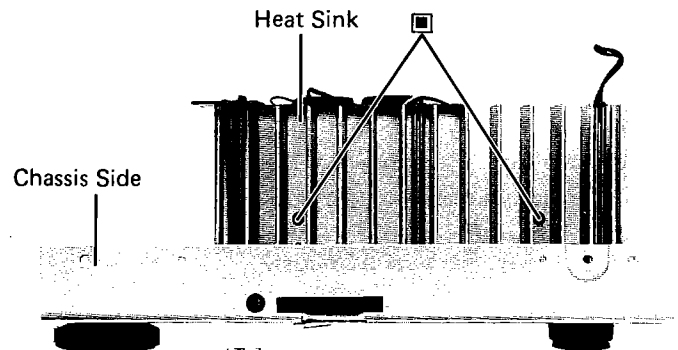
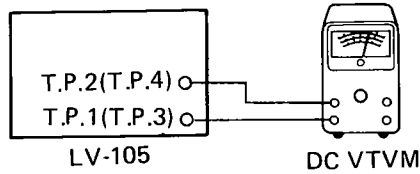

Figure 13



# Adjustment Procedures

## 1. Connection



## 2. Control Settings

Power Switch . . . . .	ON	Bass Control . . . . .	Center Position
Volume Control . . . . .	Minimum (fully counterclockwise)	Balance Control . . . . .	Center Position
Treble Control . . . . .	Center Position	Pre-Heater Switch . . . . .	ON
		Others . . . . .	OFF

## 3. Adjustment Procedure

### (1) Idling Adjustment

Adjust VR7301 (VR7302) until 55mV is obtained between T.P.1 (T.P.3) and T.P.2 (T.P.4).

**Note:** This adjustment should be made approx. 30 minutes often the power on or voltage becomes sufficiently steady state.

# Adjustment Locations

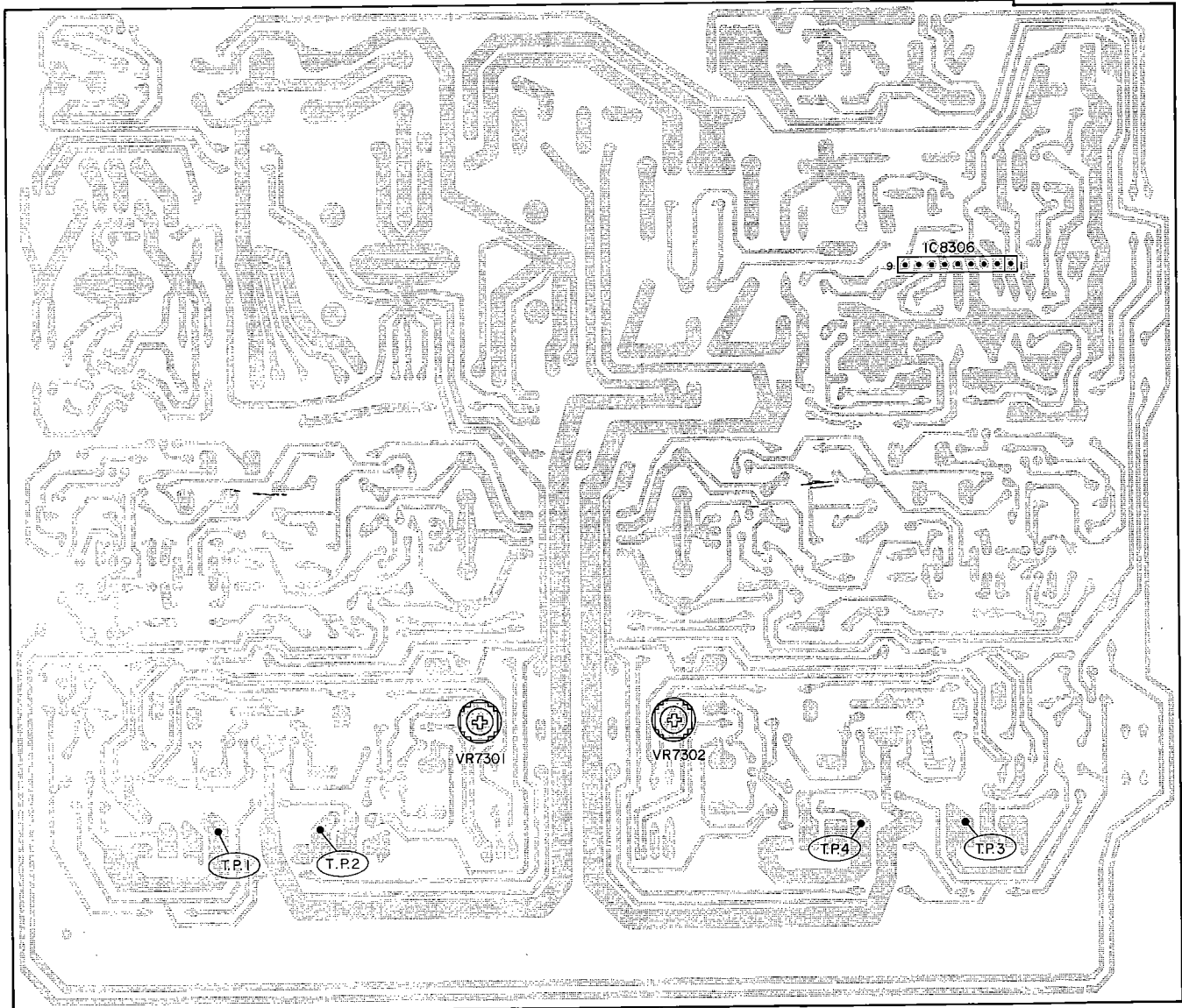

Main P.C. Board

# Block Diagram

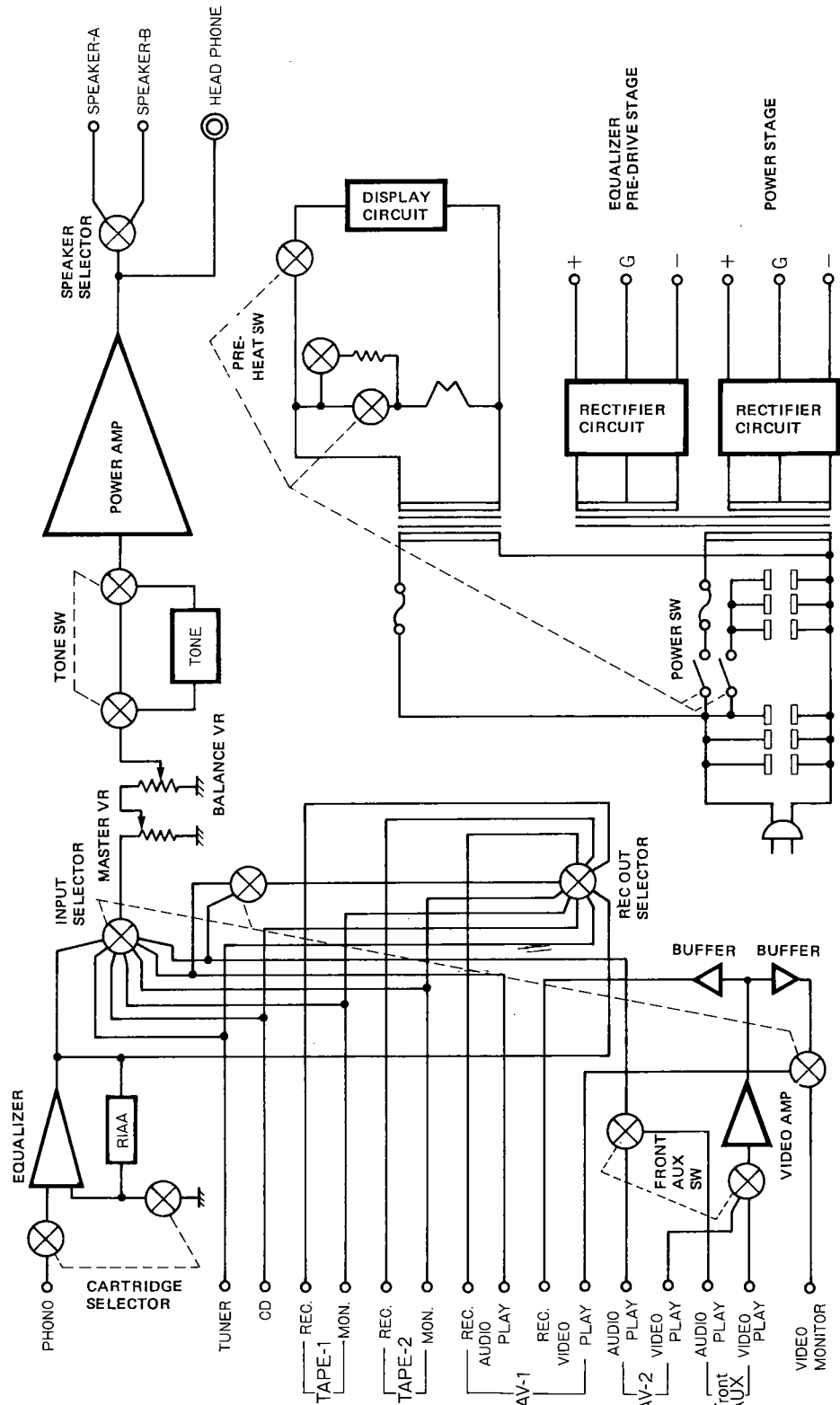

# Schematic Diagram

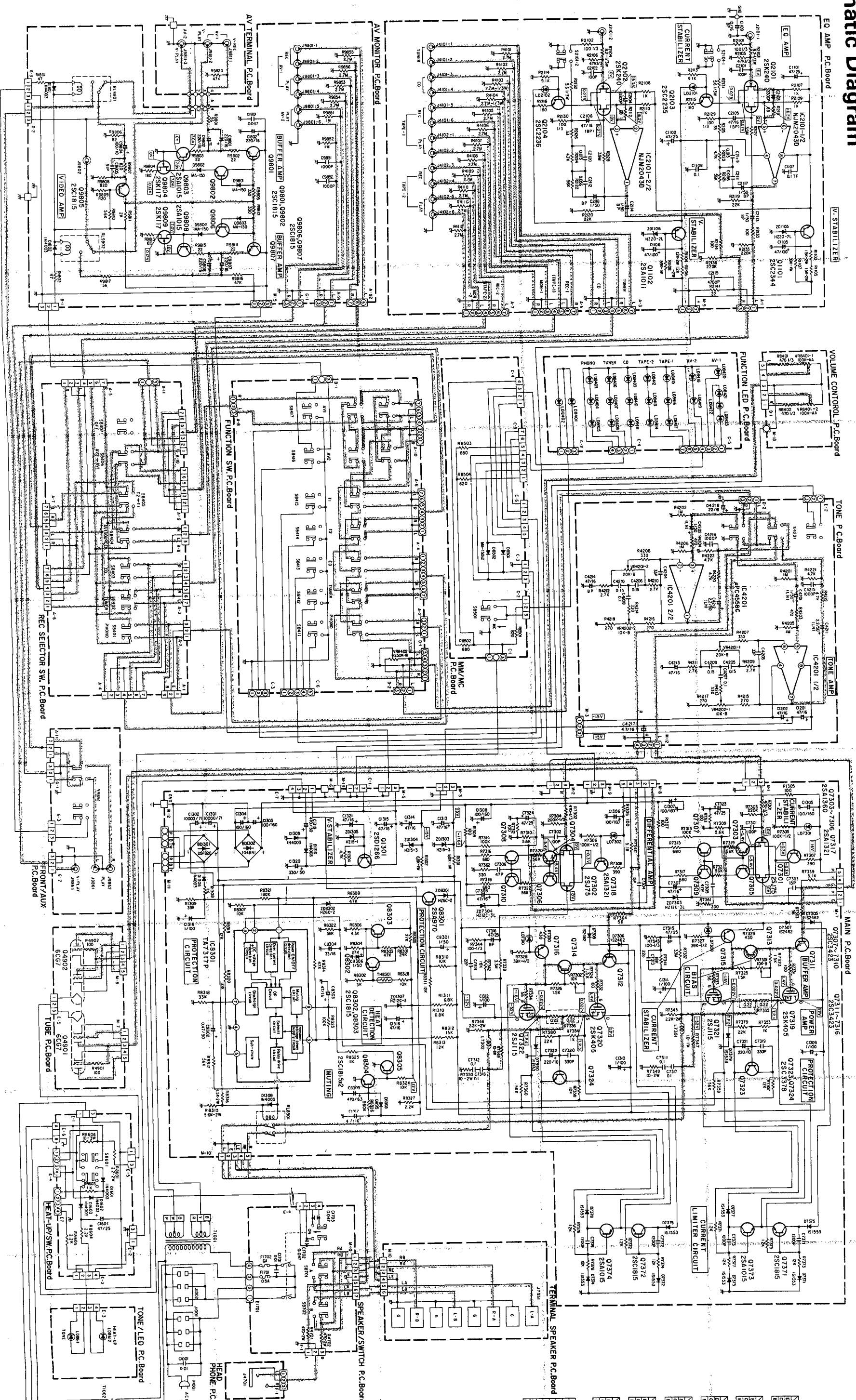

IC2101	1	2	3	4	5	6	7
IC2102	1	2	3	4	5	6	7
IC2103	1	2	3	4	5	6	7
IC2104	1	2	3	4	5	6	7
IC2105	1	2	3	4	5	6	7
IC2106	1	2	3	4	5	6	7
IC2107	1	2	3	4	5	6	7
IC2108	1	2	3	4	5	6	7
IC2109	1	2	3	4	5	6	7
IC2110	1	2	3	4	5	6	7
IC2111	1	2	3	4	5	6	7
IC2112	1	2	3	4	5	6	7
IC2113	1	2	3	4	5	6	7
IC2114	1	2	3	4	5	6	7
IC2115	1	2	3	4	5	6	7
IC2116	1	2	3	4	5	6	7
IC2117	1	2	3	4	5	6	7
IC2118	1	2	3	4	5	6	7
IC2119	1	2	3	4	5	6	7
IC2120	1	2	3	4	5	6	7
IC2121	1	2	3	4	5	6	7
IC2122	1	2	3	4	5	6	7
IC2123	1	2	3	4	5	6	7
IC2124	1	2	3	4	5	6	7
IC2125	1	2	3	4	5	6	7
IC2126	1	2	3	4	5	6	7
IC2127	1	2	3	4	5	6	7
IC2128	1	2	3	4	5	6	7
IC2129	1	2	3	4	5	6	7
IC2130	1	2	3	4	5	6	7
IC2131	1	2	3	4	5	6	7
IC2132	1	2	3	4	5	6	7
IC2133	1	2	3	4	5	6	7
IC2134	1	2	3	4	5	6	7
IC2135	1	2	3	4	5	6	7
IC2136	1	2	3	4	5	6	7
IC2137	1	2	3	4	5	6	7
IC2138	1	2	3	4	5	6	7
IC2139	1	2	3	4	5	6	7
IC2140	1	2	3	4	5	6	7
IC2141	1	2	3	4	5	6	7
IC2142	1	2	3	4	5	6	7
IC2143	1	2	3	4	5	6	7
IC2144	1	2	3	4	5	6	7
IC2145	1	2	3	4	5	6	7
IC2146	1	2	3	4	5	6	7
IC2147	1	2	3	4	5	6	7
IC2148	1	2	3	4	5	6	7
IC2149	1	2	3	4	5	6	7
IC2150	1	2	3	4	5	6	7
IC2151	1	2	3	4	5	6	7
IC2152	1	2	3	4	5	6	7
IC2153	1	2	3	4	5	6	7
IC2154	1	2	3	4	5	6	7
IC2155	1	2	3	4	5	6	7
IC2156	1	2	3	4	5	6	7
IC2157	1	2	3	4	5	6	7
IC2158	1	2	3	4	5	6	7
IC2159	1	2	3	4	5	6	7
IC2160	1	2	3	4	5	6	7
IC2161	1	2	3	4	5	6	7
IC2162	1	2	3	4	5	6	7
IC2163	1	2	3	4	5	6	7
IC2164	1	2	3	4	5	6	7
IC2165	1	2	3	4	5	6	7
IC2166	1	2	3	4	5	6	7
IC2167	1	2	3	4	5	6	7
IC2168	1	2	3	4	5	6	7
IC2169	1	2	3	4	5	6	7
IC2170	1	2	3	4	5	6	7
IC2171	1	2	3	4	5	6	7
IC2172	1	2	3	4	5	6	7
IC2173	1	2	3	4	5	6	7
IC2174	1	2	3	4	5	6	7
IC2175	1	2	3	4	5	6	7
IC2176	1	2	3	4	5	6	7
IC2177	1	2	3	4	5	6	7
IC2178	1	2	3	4	5	6	7
IC2179	1	2	3	4	5	6	7
IC2180	1	2	3	4	5	6	7
IC2181	1	2	3	4	5	6	7
IC2182	1	2	3	4	5	6	7
IC2183	1	2	3	4	5	6	7
IC2184	1	2	3	4	5	6	7
IC2185	1	2	3	4	5	6	7
IC2186	1	2	3	4	5	6	7
IC2187	1	2	3	4	5	6	7
IC2188	1	2	3	4	5	6	7
IC2189	1	2	3	4	5	6	7
IC2190	1	2	3	4	5	6	7
IC2191	1	2	3	4	5	6	7
IC2192	1	2	3	4	5	6	7
IC2193	1	2	3	4	5	6	7
IC2194	1	2	3	4	5	6	7
IC2195	1	2	3	4	5	6	7
IC2196	1	2	3	4	5	6	7
IC2197	1	2	3	4	5	6	7
IC2198	1	2	3	4	5	6	7
IC2199	1	2	3	4	5	6	7
IC2200	1	2	3	4	5	6	7

- Measuring Condi  
 (1) Power Supply  
 AC 120V  
 (2) Measuring W  
 Digital M.  
 (3) Speakers  
 (4) Measuring C  
 No Signal  
 Power SW

NOTES:  
 1. All re:  
 2. All ca



## Electrical Parts List

Resistors: Carbon resistors under 1/4 watts are not mentioned in the parts list, please confirm them by schematic diagram.  
uF = microfarads, pF = picofarads

Symbol No.	Part No.	Description
<b>Equalizer P.C. Board</b>		
<b>IC</b>		
IC2101	51T52153F01	NUM2043D-D
<b>Transistors</b>		
Q1101	48T64240F01	2SC2344
Q1102	48T47145F01	2SA1011
Q2101	48T60558F01	FET, 2SK240
Q2102	48T60558F01	FET, 2SK240
Q2103	48T51120F02	2SC2235
Q2104	48T51120F02	2SC2235
<b>Diodes/LEDs</b>		
LD2101	48T60947F06	LED, SLH-34VRS5F (RED)
LD2102	48T60947F06	LED, SLH-34VRS5F (RED)
ZD1105	48T52741F56	Zener, HZ20-2L
ZD1106	48T52741F56	Zener, HZ20-2L
<b>Jacks/Switch</b>		
J2101	09T67403F01	Plate Phone (Phone)
J4101	09T67404F01	Plate Phone (Tuner, CD)
J4102	09T67404F01	Plate Phone (Tape 1, Tape 2)
S2101	40T57372F01	Switch, Slide SSR2435 (Cartridge)
<b>Capacitors</b>		
C1101	23S40657F20	Electrolytic, 47 uF/25V
C1102	23S40657F20	Electrolytic, 47 uF/25V
C1105	23S41198U32	Electrolytic, 47 uF/100V
C1106	23S41198U32	Electrolytic, 47 uF/100V
C1107	08T57851F13	T.F., 0.1 uF
C1108	08T57851F13	T.F., 0.1 uF
C1109	23T42477F06	Electrolytic, 10 uF/16V
C2101	08T42081U01	Polystyrol, 100 pF
C2102	08T42081U01	Polystyrol, 100 pF
C2103	08T42081U37	Polystyrol, 3300 pF

Symbol No.	Part No.	Description
<b>Heater/Switch P.C. Board</b>		
<b>Diodes/Switch</b>		
D1601	48S40477U01	1N4003
D1602	48S40477U01	1N4003
D1603	48S40477U01	1N4003
S8601	40T67389F01	Switch, Push, SUL121S (Pre-heating)
<b>Capacitor/Resistors</b>		
C1601	23S40657F20	Electrolytic, 47 uF/25V
R8601	06T00007L01	Resistor Metal Oxide Film, 2.2 ohm 2W
or	06T55179F01	Resistor, Metal Film, 2.2 ohm 2W
R8606	06T60132F01	Resistor, Cement 10 ohm 3W
<b>Speaker/Switch P.C. Board</b>		
<b>Fuses/Switches</b>		
F1701	65T52486F01	Fuse, MF61NM 0.5A-125V
F1702	65T56270F01	Fuse, 61ML 6A-125V
S1701	40T61963F02	Switch, Push SDU4P (Power)
S8701	40T67388F01	Switch, Push (Speaker A)
S8702	40T67388F01	Switch, Push (Speaker B)
<b>Capacitors/Resistors</b>		
C1701	08T57437F09	Ceramic, - 0.01 uF
C1702	08T61952F01	Ceramic, 0.047 uF
C1703	08T61952F01	Ceramic, 0.047 uF
R4701	06T55179F57	Resistor, Metal Film, 470 ohm 2W
or	06T00007L57	Resistor, Metal Oxide Film, 470 ohm 2W
R4702	06T55179F57	Resistor, Metal Film, 470 ohm 2W
or	06T00007L57	Resistor, Metal Oxide Film, 470 ohm 2W
<b>Tone Control P.C. Board</b>		
<b>IC/Switch</b>		
IC4201	S1S43471U02	µPC4558C
S4201	40T61986F01	Switch, Push 122A (Tone)

Symbol No.	Part No.	Description
<b>Capacitors/Resistors</b>		
C1201	23S40657F13	Electrolytic, 47 uF/16V
C1202	23S40657F13	Electrolytic, 47 uF/16V
C4201	23T42478F24	Electrolytic, 1 uF/50V
C4202	23T42478F24	Electrolytic, 1 uF/50V
C4203	21S40655F17	Ceramic, 33 pF
C4204	21S40655F17	Ceramic, 33 pF
C4205	08T57851F15	TF, 0.15 uF
C4206	08T57851F15	TF, 0.15 uF
C4207	08T57851F13	TF, 0.1 uF
C4208	08T57851F13	TF, 0.1 uF
C4209	08T57851F15	TF, 0.15 uF
C4210	08T57851F15	TF, 0.15 uF
C4211	23T58711F31	Electrolytic, 2.2 uF/50V
C4212	23T58711F31	Electrolytic, 2.2 uF/50V
C4213	23T42477F39	Electrolytic (BP) 47 uF/16V
C4214	23T42477F39	Electrolytic (BP) 47 uF/16V
C4215	08S44503P01	Mylar, 1000 pF
C4216	08S44503P01	Mylar, 1000 pF
C4217	23S41059P18	Tantalum, 4.7 uF/16V
C4218	23S41059P32	Tantalum, 22 uF/16V
VR4201	18T67395F01	Variable, K122G 20KBB ohm (Treble)
VR4202	18T67394F01	Variable, K122G 10KBB ohm (Bass)
<b>Main P.C. Board</b>		
<b>IC</b>		
IC8301	51T67437F01	TA7317P
<b>Transistors</b>		
Q1301	48T56031F01	2SD1266
Q7301	48T62284F01	FET, 2SJ75
Q7302	48T62284F01	FET, 2SJ75
Q7303	48T64375F01	2SA1360
Q7304	48T64375F01	2SA1360
Q7305	48T64375F01	2SA1360
Q7306	48T64375F01	2SA1360
Q7307	48T64376F01	2SC3423
Q7308	48T64376F01	2SC3423
Q7309	48T64376F01	2SC3423





Symbol No.	Part No.	Description
Q7310	48T64376F01	2SC3423
Q7311	48T64376F01	2SC3423
Q7312	48T64376F01	2SC3423
Q7313	48T64376F01	2SC3423
Q7314	48T64376F01	2SC3423
Q7315	48T64376F01	2SC3423
Q7316	48T64376F01	2SC3423
Q7317	48T70874F01	2SA1321
Q7318	48T70874F01	2SA1321
Q7319	48T67399F01	FET, 2SK405
Q7320	48T67399F01	FET, 2SK405
Q7321	48T67398F01	FET, 2SJ115
Q7322	48T67398F01	FET, 2SJ115
Q7323	48T80986F01	2SC3378
Q7324	48T80986F01	2SC3378
Q7371	48S43525F03	2SC1815
or	48S44578J01	2SC945L
Q7372	48S43525F03	2SC1815
or	48S44578J01	2SC945L
Q7373	48T51118F02	2SA1015
or	48T40081T03	2SA733
Q7374	48T751118F01	2SA1015
or	48T40081T03	2SA733
Q8301	48T52545F03	2SA970
Q8302	48T81101F01	2SC1815
Q8303	48T81101F01	2SC1815
Q8304	48T81101F01	2SC1815
Q8305	48T81101F01	2SC1815
<b>Relay/Thermistor</b>		
RL8301	80T58612F01	Relay, G2Z-222P-US-24
TH8301	48T67436F01	Thermistor, NB320UASZ
<b>Coils</b>		
L7301	24T74614F01	Choke, 1.1 $\mu$ H
L7302	24T74614F01	Choke, 1.1 $\mu$ H

Symbol No.	Part No.	Description
<b>Diodes/LEDs</b>		
BD1301	48T67435F01	Bridge, D5FB20
BD1302	48T61415F03	Bridge, 1G4B41
D1306	48S40477U01	1N4003
D1308	48S40477U01	1N4003
D1309	48S40477U01	1N4003
D1310	48S40477U01	1N4003
D7305	48T52198F01	1S2462
or	48T52198F02	1S2463
D7306	48T52198F01	1S2462
or	48T52198F02	1S2463
D7307	48T52198F01	1S2462
or	48T52198F02	1S2463
D7308	48T52198F01	1S2462
or	48T52198F02	1S2463
D7371	48T71195F01	1S1553
D7372	48T71195F01	1S1553
D7373	48T71195F01	1S1553
D7374	48T71195F01	1S1553
D7375	48T71195F01	1S1553
D7376	48T71195F01	1S1553
D7377	48T71195F01	1S1553
D7378	48T71195F01	1S1553
D7379	48T71195F01	1S1553
D7380	48T71195F01	1S1553
D8303	48T43982F01	0A95
ZD1303	48T52739F78	Zener, HZ15-3
or	48T56372F59	Zener, RD16E-B1
ZD1304	48T52739F78	Zener, HZ15-3
or	48T56372F59	Zener, RD16E-B1
ZD1305	48T52739F76	Zener, HZ15E-1
or	48T56372F57	Zener, RD15-B2
ZD1307	48T52740F09	Zener, HZ12C-3
or	48T56372F57	Zener, RD15E-B2
ZD7303	48T52741F45	Zener, HZ12C-3L
ZD7304	48T52741F45	Zener, HZ12C-3L
ZD8301	48T52739F41	Zener, HZ6C-2
or	48T56372F29	Zener, RD6.2E-B2
ZD8302	48T52739F41	Zener, HZ6C-2
or	48T56372F29	Zener, RD6.2E-B2
LD7301	48T60947F06	LED, SLH-34VR5F (RED)
LD7302	48T60947F06	LED, SLH-34VR5F (RED)
LD7309	48T60947F06	LED, SLH-34VR5F (RED)
LD7310	48T60947F06	LED, SLH-34VR5F (RED)

Symbol No.	Part No.	Description
<b>Capacitors</b>		
C1301	23T67402F01	Electrolytic, 10000 uF/71V
C1302	23T67402F01	Electrolytic, 10000 uF/71V
C1303	23T67457F07	Electrolytic, 100 uF/16V
C1304	23T67457F07	Electrolytic, 100 uF/16V
C1305	23T67457F07	Electrolytic, 100 uF/16V
C1306	23T67457F07	Electrolytic, 100 uF/16V
C1307	23T67457F07	Electrolytic, 100 uF/16V
C1308	23T67457F07	Electrolytic, 100 uF/16V
C1309	23S40657F45	Electrolytic, 1 uF/10V
C1310	23S40657F45	Electrolytic, 1 uF/100V
C1311	23S40657F45	Electrolytic, 1 uF/100V
C1312	23S40657F45	Electrolytic, 1 uF/100V
C1313	23S40657F13	Electrolytic, 47 uF/16V
C1314	23S40657F13	Electrolytic, 47 uF/16V
C1315	23S40657F13	Electrolytic, 47 uF/16V
C1316	23S40657F45	Electrolytic, 1 uF/100V
C1317	23S41059P18	Tantalum, 4.7 uF/16V
C1318	23S40657F13	Electrolytic, 47 uF/16V
C1319	23T68328F63	Electrolytic, 470 uF/50V
C1320	23S41198U51	Electrolytic, 330 uF/50V
C1321	23S40657F13	Electrolytic, 47 uF/16V
C7301	08T81196F34	Mica, 100 pF
C7302	08T81196F34	Mica, 100 pF
C7303	08T81196F10	Mica, 15pF
C7304	08T81196F10	Mica, 15pF
C7305	08T81196F25	Mica, 47 pF
C7306	08T81196F25	Mica, 47 pF
C7307	23T73856F08	Electrolytic, 47 uF/16V
C7308	23T73856F08	Electrolytic, 47 uF/16V
C7311	08T68632F25	Polyester, 0.1 uF
C7312	08T68632F25	Polyester, 0.1 uF
C7313	08T81196F14	Mica, 22 pF
C7314	08T81196F14	Mica, 22 pF
C7315	23T71210F18	Electrolytic, 47 uF/25V
C7316	23T71210F18	Electrolytic, 47 uF/25V
C7317	08T68632F25	Polyester, 0.1 uF
C7318	08T68632F25	Polyester, 0.1 uF
C7319	08T52448F01	Polypropylene, 330 pF
C7320	08T52448F01	Polypropylene, 330 pF
C7321	23S40657F09	Electrolytic, 220 uF/100V

Symbol No.	Part No.	Description
C7322	23S40657F09	Electrolytic, 220 uF/100V
C7323	23T73856F13	Electrolytic, 47 uF/25V
C7324	23T73856F13	Electrolytic, 47 uF/25V
C7371	08T52448F15	Polypropylene, 120 pF
C7372	08T52448F15	Polypropylene, 120 pF
C7373	08T52448F15	Polypropylene, 120 pF
C7374	08T52448F15	Polypropylene, 120 pF
C8301	23S40657F28	Electrolytic, 1 uF/50V
C8302	23S40657F27	Electrolytic, 0.47 uF/50V
C8303	23S40657F13	Electrolytic, 47 uF/16V
C8304	23T42477F38	Electrolytic, (BP) 33 uF/16V
C8305	23S40657F50	Electrolytic, 470 uF/6.3V
C8306	23S40657F28	Electrolytic, 1 uF/50V
<b>Resistors (MO = Metal Oxide Film)</b>		
R1301 or	06T00005L85 06T55177F85	MO, 6.8K ohm 1W Metal Film, 6.8K ohm 1W
R1302 or	06T00005L85 06T55177F85	MO, 6.8K ohm 1W Metal Film, 6.8K ohm 1W
R7301	06T70909F57	Carbon Film, 470 ohm 1/3W
R7302	06T70909F57	Carbon Film, 470 ohm 1/3W
R7303	06T70910F22	Carbon Film, 220K ohm 1/3W
R7304	06T70910F22	Carbon Film, 220K ohm 1/3W
R7305	06T00018L14	Carbon Film, 100K ohm 1/2W
R7306	06T00018L14	Carbon Film, 100K ohm 1/2W
R7307	06T69013F55	Fuse, 390 ohm 1/4W
R7308	06T69013F55	Fuse, 390 ohm 1/4W
R7327	06T00018L04	Carbon Film, 39K ohm 1/2W
R7328	06T00018L04	Carbon Film, 39K ohm 1/2W
R7329	06T69013F56	Fuse, 430 ohm 1/4W
R7330	06T69013F56	Fuse, 430 ohm 1/4W
R7331	06T69013F41	Fuse, 100 ohm 1/4W
R7332	06T69013F41	Fuse, 100 ohm 1/4W
R7333	06T69013F35	Fuse, 56 ohm 1/4W
R7334	06T69013F35	Fuse, 56 ohm 1/4W
R7335	06T67397F01	Metal Plate, 0.22 ohm 5W
R7336	06T67397F01	Metal Plate, 0.22 ohm 5W
R7343	06T70909F41	Carbon Film, 100 ohm 1/3W
R7344	06T70909F41	Carbon Film, 100 ohm 1/3W
R7345 or	06T00007L73 06T55179F73	MO, 2.2K ohm 2W Metal Film, 2.2K ohm 2W



Symbol No.	Part No.	Description
R7346 or R7347 or R7348 or	06T00007L73 06T55179F73 06T00005L17 06T55177F17 06T00005L17 06T55177F17	MO, 2.2K ohm 2W Metal Film, 2.2K ohm 2W MO, 10 ohm 1W Metal Film, 10 ohm 1W MO, 10 ohm 1W Metal Film, 10 ohm 1W
R7349 or R7350 or R8315 or	06T00007L17 06T55179F17 06T00007L17 06T55179F17 06T00007L83 06T55179F83	MO, 10 ohm 2W Metal Film, 10 ohm 2W MO, 10 ohm 2W Metal Film, 10 ohm 2W MO, 5.6K ohm 2W Metal Film, 5.6K ohm 2W
R8316 or VR7301 VR7302	06T00007L69 06T55179F69 18C47132G06 18C41732G06	MO, 1.5K ohm 2W Metal Film, 1.5K ohm 2W Variable, 10K ohm Variable, 10K ohm
<b>Function/LED P.C. Board</b>		
<b>LEDs</b>		
LD8401	48T60947F05	LED, SLH-34VR3F (MM) (RED)
LD8402	48T60947F05	LED, SLH-34VR3F (MC) (RED)
LD8403	48T60947F04	LED, SLH-34MG3F (Phone) (GRN)
LD8404	48T60947F04	LED, SLH-34MG3F (Phone) (GRN)
LD8405	48T60947F04	LED, SLH-34MG3F (Phone) (GRN)
LD8406	48T60947F04	LED, SLH-34MG3F (Tuner) (GRN)
LD8407	48T60947F04	LED, SLH-34MG3F (Tuner) (GRN)
LD8408	48T60947F04	LED, SLH-34MG3F (Tuner) (GRN)
LD8409	48T60947F04	LED, SLH-34MG3F (CD) (GRN)
LD8410	48T60947F04	LED, SLH-34MG3F (CD) (GRN)

Symbol No.	Part No.	Description
LD8411	48T60947F04	LED, SLH-34MG3F (CD) (GRN)
LD8412	48T60947F04	LED, SLH-34MG3F (Tape 2) (GRN)
LD8413	48T60947F04	LED, SLH-34MG3F (Tape 2) (GRN)
LD8414	48T60947F04	LED, SLH-34MG3F (Tape 2) (GRN)
LD8415	48T60947F04	LED, SLH-34MG3F (Tape 1) (GRN)
LD8416	48T60947F04	LED, SLH-34MG3F (Tape 1) (GRN)
LD8417	48T60947F04	LED, SLH-34MG3F (Tape 1) (GRN)
LD8418	48T60947F04	LED, SLH-34MG3F (AV1, 2/AUX) (GRN)
LD8419	48T60947F04	LED, SLH-34MG3F (AV1, 2/AUX) (GRN)
LD8420	48T60947F04	LED, SLH-34MG3F (AV1, 2/AUX) (GRN)
LD8421	48T60947F05	LED, SLH-34VR3F (AV) (RED)
LD8422	48T60947F05	LED, SLH-34VR3F (AV) (RED)
LD8423	48T60947F05	LED, SLH-34VR3F (AV) (RED)
<b>Function P.C. Board</b>		
<b>Switches</b>		
S8411 ~ 8417	40T67390F01	Push (Phono, Tuner, CD, Tape 2, Tape 1, AV2, AV1)
<b>Resistor</b>		
VR8402	18T67392F01	Variable, K121MO 250KW (Balance)
<b>MM/MC P.C. Board</b>		
<b>Diodes</b>		
D8501 or D8502 or	48T51582F01 48T51881F01 48T51582F01 48T51881F01	MA-150 DS442 MA-150 DS442

Symbol No.	Part No.	Description
<b>Switch</b>		
S8501	40T67441F01	Push, SUFR512 (Cartridge)
<b>AV Monitor P.C. Board</b>		
<b>Transistors</b>		
Q9801	48T81101F01	2SC1815
Q9802	48T81101F01	2SC1815
Q9803	48T51118F01	2SA1015
Q9804	48S47729F03	FET, 2SK117
Q9805	48T81101F01	2SC1815
Q9806	48T81101F01	2SC1815
Q9807	48T81101F01	2SC1815
Q9808	48T51118F01	2SA1015
Q9809	48S47729F03	FET, 2SK117
<b>Diodes</b>		
D1801	48S40477U01	1N4003
D1802	48S40477U01	1N4003
D9801	48T51582F01	MA-150
or	48T51881F01	DS442
D9802	48T51582F01	MA-150
or	48T51881F01	DS442
D9803	48T51582F01	MA-150
or	48T51881F01	DS442
D9804	48T51582F01	MA-150
or	48T51881F01	DS442
<b>Relays/Jack</b>		
RL9801	80B42571P03	G2E 12V
RL9802	80B42571P03	G2E 12V
J9801	09T67440F01	Jack, Plate Phone (AV1, AV2)
<b>Capacitors</b>		
C1801	08T52714F21	Ceramic, 0.047 uF
C1802	23S40657F52	Electrolytic, 220 uF/16V
C9801	23S40657F52	Electrolytic, 220 uF/16V
C9802	23S41198U41	Electrolytic, 220 uF/16V
C9804	23S40657F08	Electrolytic, 100 uF/10V
C9805	08S44505P36	Ceramic, 91 pF
C9807	23S40657F52	Electrolytic, 220 uF/16V
C9808	23S40657F52	Electrolytic, 220 uF/16V
C9851	08T42081U25	Polystyrol, 1000 pF
C9852	08T42081U25	Polystyrol, 1000 pF

Symbol No.	Part No.	Description
<b>AV Terminal P.C. Board</b>		
<b>Jack</b>		
J9811	09T67439F01	Headphone (AV-1, AV-2)
<b>Front/AUX P.C. Board</b>		
<b>Jacks/Switch</b>		
J9861	09T67396F01	Plate Phone (Front AV/AUX AUDIO)
J9862	09T67396F01	Plate Phone (Front AV/AUX AUDIO)
J9863	09T67396F01	Plate Phone (Video)
S9861	40T67387F01	Switch, Push SUL121A (AV/AUX, Front/Rear)
<b>Miscellaneous</b>		
J1001	09T67405F02	Outlet, AC
J1002	09T67405F02	Outlet, AC
J4701	09T66672F01	Headphone Jack
J7351	09T60544F01	Terminal, Speaker
J9802	09T67438F01	Plate, Phone Jack (Video Monitor)
LD8611	48T60947F05	LED, SLH-34VR3F (RED) (Tone)
LD8612	48T60947F05	LED, SLH-34VR3F (RED) (Pre-Heating)
P1001	28T55335F02	Plug AC Cord
Q4901	65T00091L01	Vacuum Tube (6CG7)
Q4902	65T00091L01	Vacuum Tube (6CG7)
R8401	06T70909F57	Resistor, Carbon 470 ohm N 1/3W
R8402	06T70909F57	Resistor, Carbon 470 ohm 1/3W
S8401 ~ 8407	40T67391F01	Switch, Push (Phono, Tuner, CD, AV/Source, Tape 2/ Tape 1, AV-2/AV-1, OFF)
T1001	25T69008F01	Power Transformer
T1002	25T68578F06	Power Transformer
VR8401	18T67393F01	Variable Resistor, 100K ohm (Volume Control)
C1001	08T57437F09	Capacitor, Ceramic 0.01 uF

# Exploded View (Cabinet)

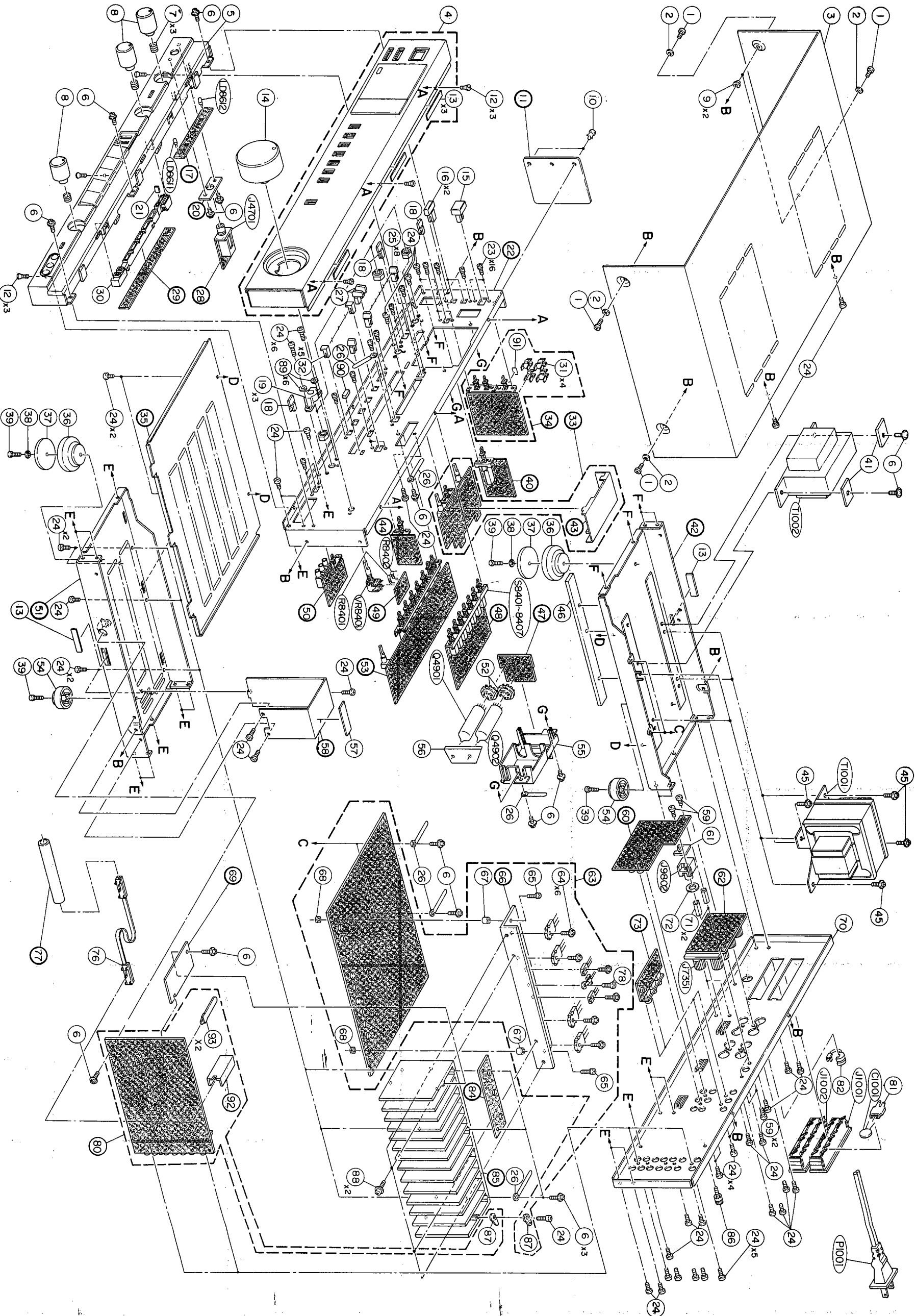

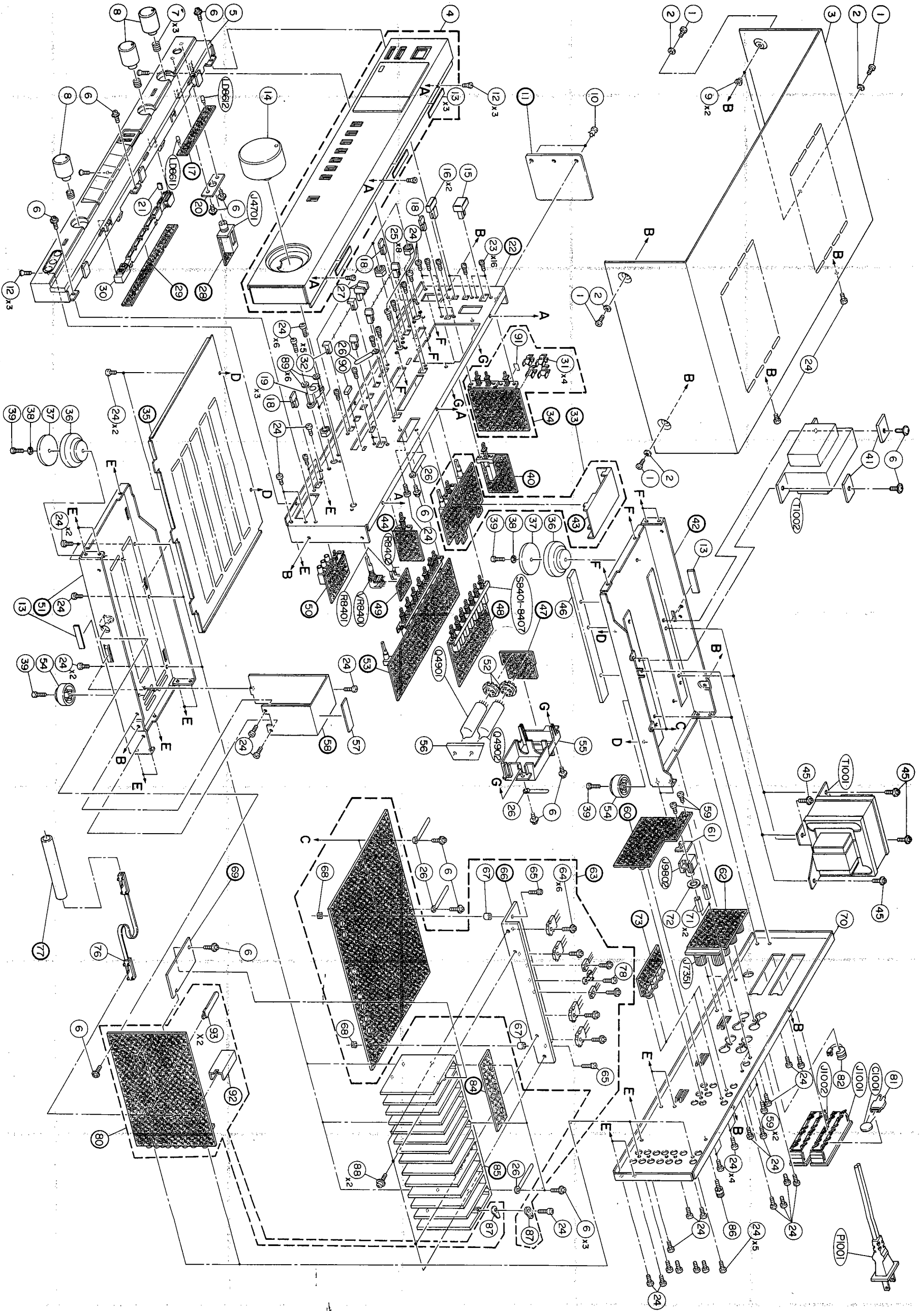

## Cabinet Assembly Parts List

Symbol No.	Index	Part No.	Description
1		03S63857F01	Screw, Tapping (M4 x 10)
2		04A65640F04	Washer, Fiber (M4)
3	1-B	15D67323F01	Cover, Top
4	3-B	01V69100F72	Assembly, Front Panel
5	5-B	01V68500F35	Assembly, Front Escutcheon
6		03S40018G08	Screw, Tapping (M3 x 8)
7	5-B	41A68570F01	Spring, Volume
8		36A67337F01	Knobs, Tone Control
9	2-C	43A68460F01	Bushing
10	3-C	05B41635J04	Rivet, Push
12		03S40012G98	Screw, Tapping (M3 x 8)
13		14S53017F64	Cover, Insulator
14	4-C	36B67336F01	Knob, Volume Control
15	3-C	36A67330F02	Switch, Push (Power)
16	3-C	36A67331F01	Button, Push (Speaker Select)
18		36A67333F01	Knob, Push
19	4-D	15A69033F01	Guide, Volume
21	5-C	14S58462F59	Cover, Insulator
23	3-D	03D40014G04	Screw, W/Washer (M3 x 6)
24		03S40012G93	Screw, Tapping (M3 x 8)
25	4-D	36A67332F01	Knob, Push (REC Out)
26		29C41045P05	Lug, Cord
27	4-D	36A67334F01	Knob, Push (AV)
30	5-D	07B67320F01	Assembly, Frame LED
31	3-D	09T51960F01	Holder, Fuse
32	4-D	43A67342F01	Spacer, Switch
36		75A67063F02	Leg
37		75A67064F01	Felt
38		04S40072G15	Washer, Toothed Lock, B (M4,3)
39		03S44205G28	Screw, Bind (M4 x 16)
41	1-E	07A40871F01	Support Trans Washer
45		03S40036U01	Screw, W/Washer (M4 x 8)
46	3-F	75A68381F01	Cushion
52	3-F	09T64527F02	Socket, Vacuum Tube
54		75T57059F01	Pad, Leg
55	3-F	07C67318F01	Tube Frame
56	3-F	75A67341F01	Cushion
57	4-F	75A57803F11	Cushion
59		03S43997F76	Screw, Bind (M3 x 6)
61	2-G	14A68351F01	Insulator

Symbol No.	Index	Part No.	Description
64	3-G	03C40121T13	Screw, W/Double Washer (M3 x 10)
65		03D40014G32	Screw, W/Washer (M3 x 6)
67		43A63128F02	Spacer, Holder
68		02B47353F02	Nut, Hex. (M3)
70	1-G	15C67324F05	Cover, Rear
71	2-G	47B64899F16	Stud
72	2-G	04A40072F03	Washer, Felt (M9,2)
76	5-H	45T67442F01	Wire, Flexible
78	2-H	03C40121T17	Screw, W/Double Washer (M3 x 8)
81	1-H	43T53136F01	Bush, Cap
82	1-H	43B41625J02	Holder, Cord
86	2-1	29T66964F01	Ground Terminal
87	3-1	29A41814G01	Lug, Cord
88	4-1	03C40121T15	Screw, W/Double Washer (M3 x 12)
89	4-D	04S40070G23	Washer, Flat (M3,3)
90	4-D	75S62361F71	Cushion, Rubber
91	3-D	54B62266F06	Label, Fuse (6A-125V)
93	5-H	29C41045P07	Lug, Board In Type (30mm)

## Packing Method View

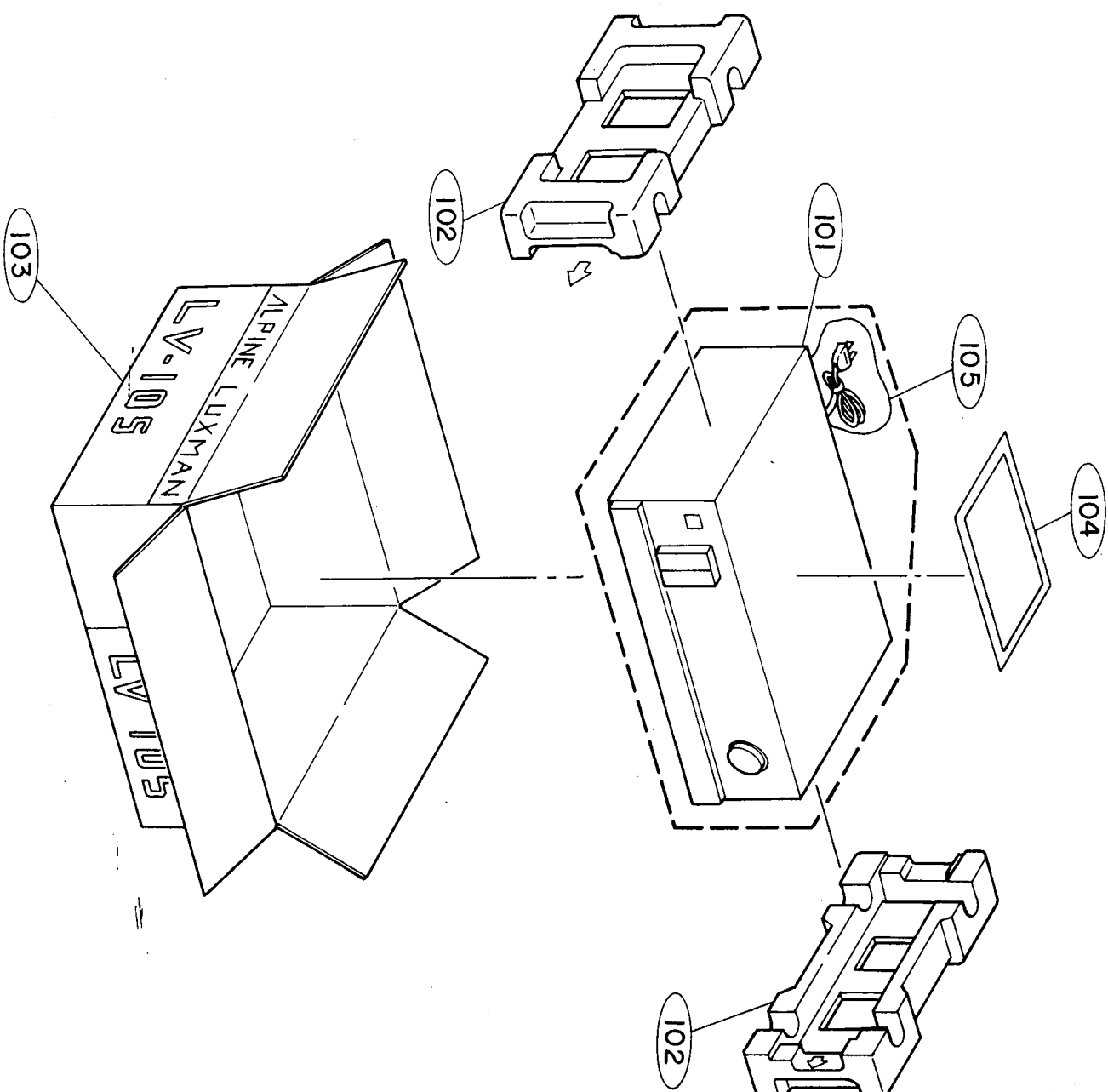

## Packing Assembly Parts List

Symbol No.	Part No.	Description
101	56B40442T13	Front Frame
102	56D67465F01	Tray, Packing
103	56S60482F70	Carton, Packing (Individual)
104	68P73333F79	Owner's Manual
105	56B40230G08	Sack, Polyethylene

Symbol No.	Part No.	Description

NOTE: The parts without part number are not supplied.



# Semi-Conductor Lead Identification

NJM2043D: IC2101

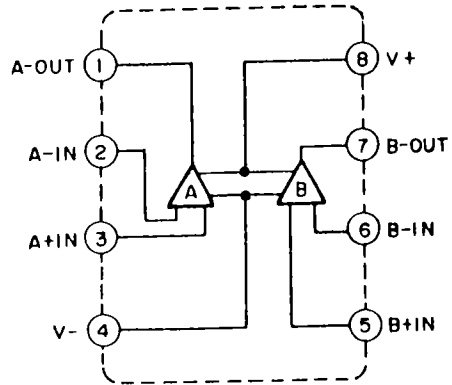
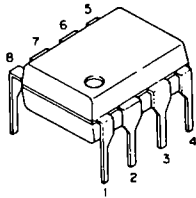

μPC4558C: IC4201

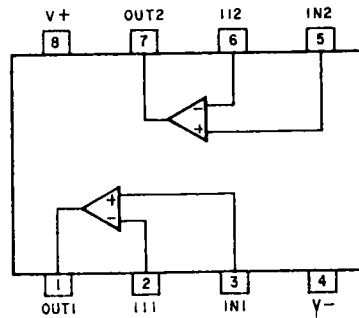
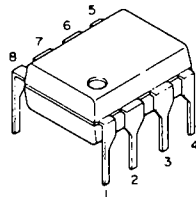

TA7317P: IC8301

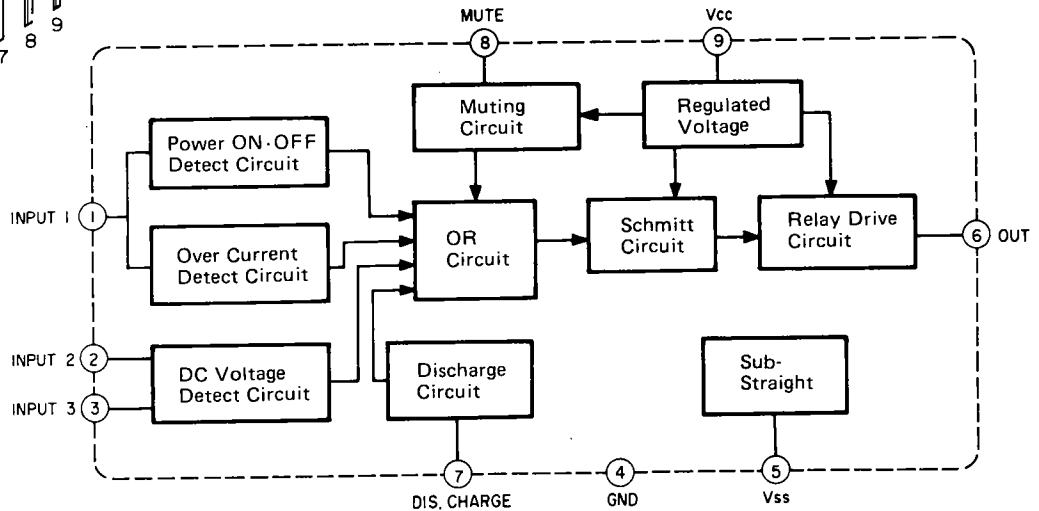
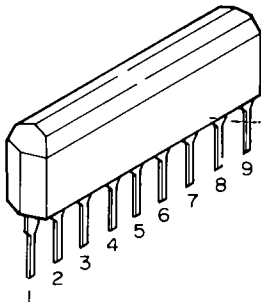

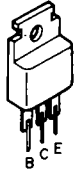
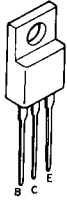
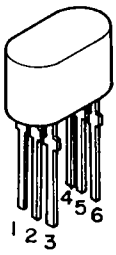
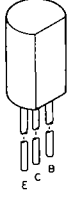
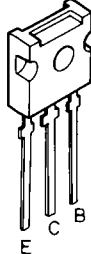
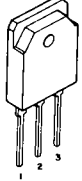
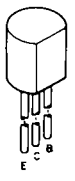
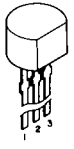
<p><b>2SC2344:</b> Q1101 <b>2SA1011:</b> Q1102</p> 	<p><b>2SD1266:</b> Q1301</p> 	<p><b>2SK240:</b> Q2101, 2102 <b>2SJ75:</b> Q7301, 7302</p>  <p>1. Source 1 2. Gate 1 3. Drain 1 4. Drain 2 5. Gate 2 6. Source 2</p>
<p><b>2SC2235:</b> Q2103, 2104 <b>2SA1321:</b> Q7317, 7318</p> 	<p><b>2SA1360:</b> Q7303 ~ 7306 <b>2SC3423:</b> Q7307 ~ 7316</p> 	<p><b>2SK405:</b> Q7319, 7320 <b>2SJ115:</b> Q7321, 7322</p>  <p>1: GATE 2: DRAIN 3: SOURCE</p>
<p><b>2SC945</b> } : Q7371, 7372 <b>2SC1815</b> } <b>2SA733</b> } : Q7373, 7374 <b>2SA1015</b> } <b>2SA970:</b> Q8301 <b>2SC1815:</b> Q8302 ~ 8305, Q9801, 9802, 9805, Q9806, 9807 <b>2SA1015:</b> Q9803, 9808</p> 		<p><b>2SK117:</b> Q9804, 9809</p>  <p>1. Drain 2. Gate 3. Source</p>
<p><b>2SC3378:</b> Q7323, 7324</p> 